

Pinell of Norway



User Manual

SUPERSOUND 901

DAB/DAB+ / FM / Internet Radio / Podcasts / Bluetooth / Spotify / CD Player

Important Safety Instructions



- Read these instructions
- Keep these Instructions
- Heed all Warnings
- Follow all instructions
- Do not use the speaker near water
- Clean only with dry cloth

WARNING: DO NOT EXPOSE THIS SPEAKER TO RAIN OR MOISTURE.

1. Do not place unit near any heat source such as radiators, heat registers, stoves, or other apparatus that produce heat.
2. Do not attempt to use unit in temperatures outside the range of 0°C~40°C.
3. Do not block any ventilation openings of unit.
4. The unit shall not be exposed to dripping or splashing. No objects filled with liquids, such as vases, shall be placed on the unit.
5. Do not place any heavy loads onto the unit, and do not step on it.
6. Please read Rating Labels at the rear of unit for power input and other safety information.
7. This unit is intended to be used only with the power supply provided.
8. Protect the power cord from being walked on or pinched particularly at the plugs, convenience receptacles, and at any point where they exit from the unit.
9. Never unplug your unit by pulling on the power cord. Always grasp the plug firmly and pull straight out from the outlet.
10. Replace all electric service cords that have become frayed or otherwise damaged immediately. Do not use a cord that shows cracks or abrasion damage.
11. Unplug the unit for additional protection during thunderstorms or when the unit is not used for prolonged periods.
12. Any service work should be carried out by qualified technicians only.
13. The cabinet may only be opened by qualified technicians.
14. The normal function of the product may be disturbed by strong Electro-Magnetic Interference. If so, relocate the source of disturbance. Reset the product to resume normal operation.
15. The means of disconnecting this apparatus from the mains supply is plug of adapter. The disconnect device shall remain readily operable.
16. In the interests of safety and to avoid unnecessary energy consumption, never leave the unit switched on while unattended for long periods of time, e.g. overnight, while on holiday or while out of the house. Switch it off and disconnect the mains plug from the mains socket.

Table of Contents

Important Safety Instructions	2
Table of Contents	3
Your Radio	5
Front View	5
Rear View	5
Remote Control View	6
Getting Started	7
Setup Wizard	8
DAB+ Mode	10
Selecting DAB+ Mode	10
Selecting a Station	10
Scanning Stations	10
Manual Tune	10
Prune Invalid	11
DRC (Dynamic Range Control) value	11
Changing Station Order	11
Viewing Station Information (via Remote Control)	11
Storing Preset Stations	12
Recalling a Preset Station	12
FM Mode	13
Selecting FM Mode	13
Scan settings	13
Viewing Station Information (via Remote Control)	13
Storing Preset Stations	13
Recalling a Preset Station	13
Internet Radio Mode	14
Storing Preset Stations	14
Recalling a Preset Station	14
Podcasts Mode	15
Storing Preset Stations	15
Recalling a Preset Station	15
Spotify Connect Mode	16
Bluetooth Mode	16
Audio In (RCA) Mode	17
CD Player	18
Adjust the CD playback (via Remote Control)	18
Music Player Mode	19
OCTIV App	19
General Operation	20
Setting Sleep (via Remote Control)	20
Setting Alarm	20
Setting Equaliser	21
Network Setup	21

Setting Time/Date	22
Setting Language	22
Factory Reset	22
Software Update – Over the network	23
Setup Wizard	23
Viewing System Info	23
Setting Backlight.....	24
Troubleshooting	25
Specifications.....	26

Your Radio

Front View

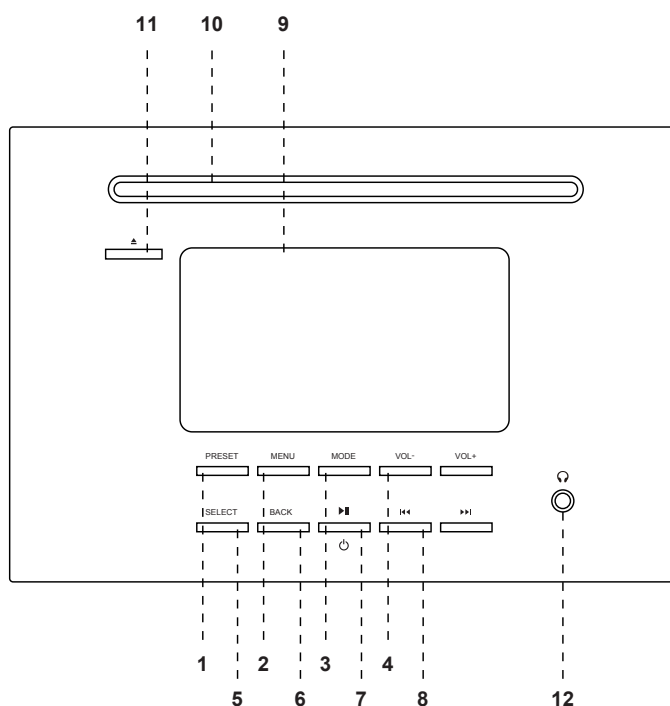





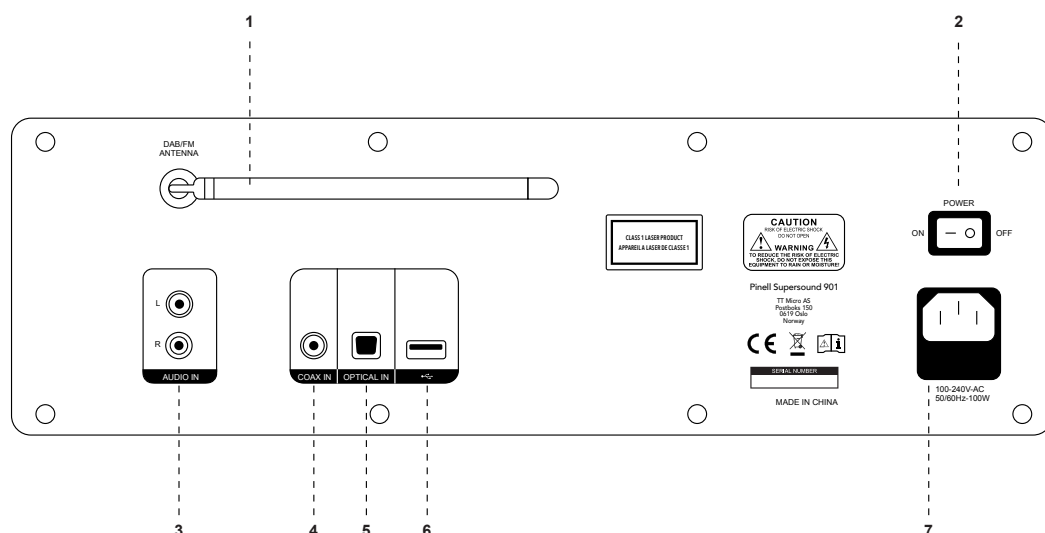





- | | |
|--|---|
| <ol style="list-style-type: none"> 1. PRESET button 2. MENU button
Press - display or close menu 3. MODE button
Press - switch between DAB, FM, Internet Radio, Spotify, Music Player, Bluetooth, CD und Audio In Mode 4. ▲+ / ▼- Volume buttons
Press - change Volume 5. SELECT button
Press - select/confirm | <ol style="list-style-type: none"> 6. BACK button
Press - back to previous menu 7. ▶▶ / STANDBY button
Press - switch on the radio or put it to standby
Switch off alarm 8. ◀◀ / ▶▶ button
Press - select (FF/FB CD mode) 9. Display 10. CD Player 11. EJECT button 12. Headphone jack |
|--|---|

Rear View



- | | |
|---|--|
| <ol style="list-style-type: none"> 1. DAB/FM Antenna (removable) 2. POWER toggle switch 3. AUDIO IN (RCA) 4. COAXIAL IN | <ol style="list-style-type: none"> 5. OPTICAL IN 6. USB 7. AC In power socket |
|---|--|

Remote Control View

1.  **Standby** button
Press - switch on the radio or put it to standby
2.  **CD/Eject** button
Press: stop / eject CD
3. **MODE** button
Press - switch between DAB, FM, Internet Radio, Podcasts, Spotify, CD, Audio In and Bluetooth
4. **MENU** button
Press - display or close menu
5. **BACK** button
Press - back to previous menu
6. **1-10** buttons
7. **P** button
Press - Display list
8. **MUTE** button
Press - mute on/off
9. **BASS** button
Press - subwoofer on/off
10. **DIMMER** button
Press - changes display backlight setting
11.  /  buttons (general)
Press - select option
12.  + /  **VOLUME +/-** buttons
Press - change volume
13.  /  buttons (CD-Player and Bluetooth)
Press - previous/next title / press & hold - fast forward/backward
14. **OK** button
Press - select/confirm
15. **EQ** button
Press - switching between equaliser settings
16. **BT PAIR** button
Press - connect Bluetooth device
17.  **Repeat/Shuffle** button
For CD mode
18.  button (CD-Player and Bluetooth)
Press - pause/play title
19. **SNOOZE** button
Press - activate snooze when alarm goes on
20. **INFO** button
Press - show station information step by step
21. **SLEEP** button
Press - set sleep time
22. **ALARM** button
Press - set Alarm 1 and/or 2

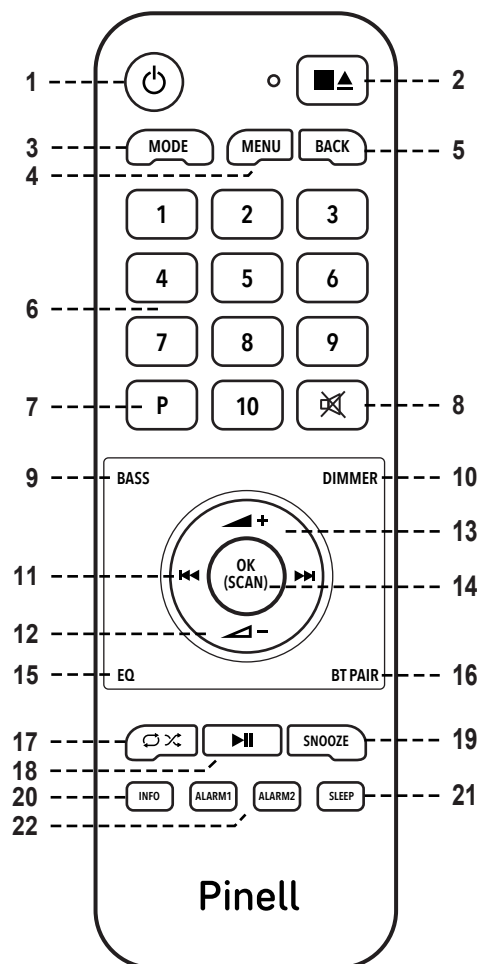

Getting Started

Carefully remove your radio from the box. You may wish to store the packaging for future use.

What you can find inside of your package

- 1x Main unit Supersound 901
- 1x Power cable
- 1x Remote control and 2x AAA alkaline battery
- 1x Quick start guide

Positioning your Radio

Place your radio on a flat / stable surface that is not subject to vibrations.

Avoid the following locations:

- Where the unit will be exposed to direct sunlight.
- Where the unit will be close to heat radiating sources.
- Where the humidity is high and ventilation is poor.
- Where it is dusty.
- Where it is damp or there is a possibility of water dripping or splashing onto unit.

Adjusting the Antenna

Mount and fully extend the antenna to ensure you receive the best reception possible in both DAB and FM radio modes. It may be necessary to adjust the position of the radio and/or antenna to achieve the best signal.

Turning the Unit On/Off

Connect the power cable plug to the AC IN power socket on the rear of unit. Then insert the power connector into the mains socket. Switch the **POWER** toggle switch to on and the radio will go to standby.

Press **STANDBY** button to turn on the radio. To turn off unit completely, unplug the power cable from the mains socket.

Replacing batteries:

1. Open the battery compartment cover at the back of your remote control.
2. Install 2pcs new AAA size batteries, referring to the marking direction inside the battery compartment.

 **Note:** do not reverse any battery and do not mix battery types, also do not mix old and new batteries. When discard your old battery, please considering eco-friendly.

3. Re-insert the battery compartment cover.

Setup Wizard

1. For initial use, radio will ask you to choose the language:
Push **◀◀** / **▶▶** - select language - push **SELECT** to confirm
2. The “Setup wizard” screen will appear.



3. Press **◀◀** / **▶▶** to confirm “YES” and press **SELECT** to start setup.
Options include the following:

Date/Time

Set 12 or 24 hour format

Auto update

Synchronously update clock from the mode you select or set by manually.

- Update from DAB
- Update from FM
- Update from Network
- No update - Set date and time manually.

Keep network connected

Keeps network connected also in standby-mode to enable use of Spotify and OCTIV app all time.

Select “YES” or “NO” (energy saving)

4. The Wizard will now scan your location for accessible wireless networks. When the scan has finished, a list of networks will be displayed.

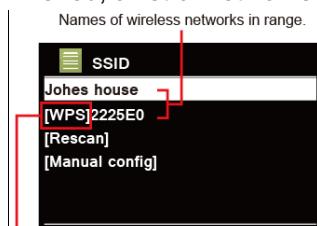

WPS security is available for this network.

Devices that support connection via WPS (Wi-Fi Protected Setup) are identified in the list as **[WPS]**.

5. Press **◀◀** / **▶▶** to select your wireless network and press **SELECT**.
 - 1) If a WEP/WPA key (password) is required, radio will ask you to input the WEP/WPA code and display the password entry screen as follows:

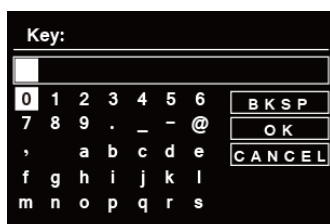

 **Note:** If a password (WEP/WPA) isn't required by your network, radio will connect to the network automatically.

a. Press **◀◀** / **▶▶** to cycle through the alphanumeric character list, press **SELECT** to select an appointed character.

 **Note:** WEP/WPA pass codes are case-sensitive.

b. If a wrong operation is being conducted, select **B K S P** to delete designated character.

 **Note:** **B K S P** = Backspace; **CANCEL** means return to previous track; radio will automatically save the WEP/WPA you've input, so no bother to re-enter these codes.

c. After selecting the final character of your password, press **◀◀** / **▶▶** to **OK**, and then press **SELECT** to confirm. The radio is connected to your wireless network.

2) If you wish to establish a connection via WPS, press **SELECT** after you have selected desired network. The radio then offers the option to initiate WPS.

Press **◀◀** / **▶▶** to select between Push Button, PIN and Skip WPS, press **SELECT** to confirm.

Push Button	<p>You must start the WPS scan on the remote station (e.g. router). Consult the manual for your router or Access Points (AP) to learn how to do this.</p> <p>After you have done this, press SELECT on the radio and then both devices will establish a connection.</p>
PIN	<p>The radio creates an 8-digit number, which you then have to enter into the remote station.</p> <p>After entering the PIN, press SELECT to establish the connection between both devices.</p>
Skip WPS	<p>In addition to a WPS connection, you can also establish a connection using a Pre-Shared-Key. The required key is often on the rear of the router, or you may have defined it yourself.</p> <p>This method is used automatically for networks without WPS. You can call up the Pre-Shared-Key function on networks with WPS by selecting menu item "Skip WPS".</p> <p>An input field should now appear. You can enter the required key (PSK) by pressing ◀◀ / ▶▶ and then pressing SELECT.</p> <p>Select "OK" and press SELECT to complete the entry. The radio should now establish the connection to the network.</p>

6. Press **SELECT**. The display will indicate "Setup wizard completed". Press **SELECT** and then press **◀◀** / **▶▶** to select the desired mode (e.g. DAB). Press **SELECT**.

DAB+ Mode

Selecting DAB+ Mode

1. Press **MODE** button repeatedly to select DAB mode.
2. For initial use, radio will carry out a full scan and store stations list in memory

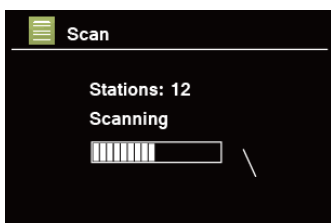

3. Once the scanning is completed, the DAB+ stations will be displayed in alphanumeric order. Press **◀◀** / **▶▶** to select you desired station and then press **SELECT** to broadcast.

🔊 Note: if no DAB+ signal is found in your area, it may be necessary to relocate your radio to a stronger signal area.

Selecting a Station

1. While a program is playing, press **MENU** button, press **SELECT** to select “Station list”.
2. Press **◀◀** / **▶▶** to select the station you want to play, and then press **SELECT** to confirm.

*🔊 Note: alternatively, press **◀◀** / **▶▶** to cycle through station list*

Scanning Stations

Press **MENU** button - press **◀◀** / **▶▶** to select “Scan” press **SELECT** to run full scan.

Manual Tune

This can help you when adjusting your antenna or when adding stations that were missed while auto tuning.

1. Press **MENU** button, press **◀◀** / **▶▶** to select “Manual tune”, and then press **SELECT** to confirm, the display will show the channel number and frequency.
2. Press **◀◀** / **▶▶** to select the channel you wanted, and then press **SELECT** to confirm.

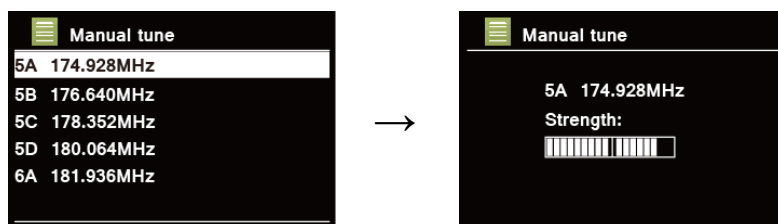

🔊 Note: If there is a multiplex corresponding to the channel and frequency, the display will show signal strength and multiplex name after a few seconds. The new station will be added to station list.

3. To play the station, first press **BACK** repeatedly to exit manual tune.

Prune Invalid

You may remove all unavailable stations from the station list.

1. Press **MENU** button, press **◀◀** / **▶▶** to select “Prune invalid”, and then press **SELECT** to confirm.
2. Press **◀◀** / **▶▶** to select “YES”, and then press **SELECT** to confirm removing all invalid stations.

DRC (Dynamic Range Control) value

If you are listening to music with high dynamic range in a noisy environment (for example classical music while cooking), you may wish to compress the audio dynamic range. This makes quiet sounds louder and loud sounds quieter.

1. Press **MENU** button, press **◀◀** / **▶▶** to select “DRC”, and then press **SELECT** to confirm.
2. Press **◀◀** / **▶▶** to select “DRC high”, “DRC low” or “DRC off”, and then press **SELECT** to confirm.

Changing Station Order

You may want to display the stations in different order.

1. Press **MENU** button, press **◀◀** / **▶▶** to select “Station order”, and press **SELECT** to confirm.
2. Press **◀◀** / **▶▶** to select “Alphanumeric” or “Ensemble”.

Alphanumeric	Display all stations in alphanumeric order.
Ensemble	List currently broadcasting active stations before inactive ones.

Viewing Station Information (via Remote Control)

DAB+ stations broadcast additional information. Press **INFO** button repeatedly while a program is playing to view information through DLS (Dynamic Label Segment), Ensemble, Program Frequency, Signal Quality, Signal Strength, Bitrate, Codec, Channel and Date.

 **Note:** to view station information while the display is playing slide show in full screen, press **BACK** to play slide show in small image, and then you can press **INFO** button repeatedly to view information. Press **BACK** a second time to play slide show in full screen again.

Showing Signal Strength

While you selected signal strength, a signal bar with the strength of the current station will show on the display.

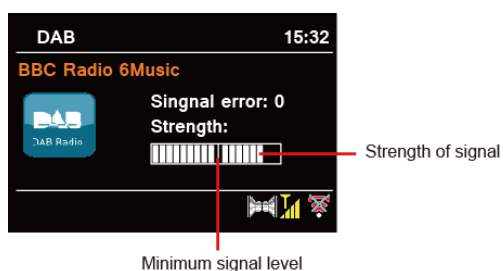

The indicator on the signal bar shows the minimum acceptable signal level.

 **Note:** Stations with signal strength below the minimum signal level may not provide a steady stream of audio.

Storing Preset Stations

Your radio can store up to 20 of your favorite DAB+ stations. This will enable you to access your favorite stations quickly and easily.

1. While playing your favorite station, press & hold **PRESET** until display shows “Save to Preset”.
2. Press **◀◀** / **▶▶** to select the position. Press **SELECT** and display will show “Preset stored”.
3. Preset number “P #” (# = 1-20) will show on the display.

Recalling a Preset Station

1. Press **PRESET** – select station by pressing **◀◀** / **▶▶** / and press **SELECT** to confirm.
2. The display will show “Not set/Preset empty” if the preset position is not allocated.

FM Mode

Selecting FM Mode

1. Press **MODE** button repeatedly to select FM mode.
2. For initial use, it will start at the beginning of the FM frequency range (87.50MHz). Otherwise, the last listened FM station will be selected.



3. **To manually scan**, while FM frequency shows up, push **◀◀** / **▶▶** to change frequency by 0.05MHz per step.
4. **To automatically scan**, while FM frequency shows up, press & hold **◀◀** / **▶▶** and your radio will automatically search until it reached the next available station.

Scan settings

This enables you set FM scans stop at stations with strong signal or stop at any available station.

1. Press **MENU** button, press **◀◀** / **▶▶** to select “Scan setting”, and then press **SELECT** to confirm.
2. Display will show “Strong stations only?”, press **◀◀** / **▶▶** to select “YES”, and then press **SELECT** to confirm. The scans stop only at stations with good signal strength.
3. Press **◀◀** / **▶▶** to select “NO”, and then press **SELECT** to confirm. The scans stop at any available station. This may result in poor quality audio from weak stations.

Viewing Station Information (via Remote Control)

There is a variety of station information transmitted by broadcaster. To view currently playing station information, press **INFO** button on the remote control repeatedly and the display will show information referring to Radio text, Program Type, Program Name and Date.

Storing Preset Stations



Your radio can store up to 20 of your favorite FM stations. This will enable you to access your favorite stations quickly and easily.

1. While playing your favorite station, press & hold **PRESET** until display shows “Save to Preset”.
2. Press **◀◀** / **▶▶** to select the position. Press **SELECT** and display will show “Preset stored”.
3. Preset number “P #” (# = 1-20) will show on the display.

Recalling a Preset Station

1. Press **PRESET** – select station by pressing **◀◀** / **▶▶** / and press **SELECT** to confirm.
2. The display will show “Not set/Preset empty” if the preset position is not allocated.

Internet Radio Mode



1. Press **MODE** button repeatedly to select Internet Radio mode.
2. Press **MENU** and  /  to select "Station list", press **SELECT** to confirm.
The Station list is composed of different categories and search functions:
 - <Country> is preset by country (e.g. UK)
 - Search
 - Location
 - Popular
 - Discover
3. Make a selection and press **SELECT** to confirm.

The Station list menu is provided by the Internet Radio Portal and is therefore only accessible when Supersound 901 is connected to the Internet. Station lists and submenus may change from time to time.



- "Country" changes depending on your current location (e.g. UK). It shows local stations of your current location.
- "Search" enables you to enter all or part of station name to find a station.
- "Location" enables you to choose from the radio stations provided by any country which you choose from a list.
- "Popular" enables your radio to list the stations that have the most listeners.
- "Discover" enables your radio to list the stations that have recently joined the Internet radio network.

Storing Preset Stations



Your radio can store up to 20 of your favorite Internet Radio stations. This will enable you to access your favorite stations quickly and easily.

1. While playing your favorite station, press & hold **PRESET** until display shows "Save to Preset".
2. Press  /  to select the position. Press **SELECT** and display will show "Preset stored".
3. Preset number "P #" (# = 1-20) will show on the display.

Recalling a Preset Station

1. Press **PRESET** – select station by pressing  /  / and press **SELECT** to confirm.
2. The display will show "Not set/Preset empty" if the preset position is not allocated.

Podcasts Mode



1. Press **MODE** button repeatedly to select Podcasts mode.
2. Press **MENU** and  /  to select "Podcast list", press **SELECT** to confirm.
The Podcast list is composed of different categories and search functions:
 - <Country> is preset by country (e.g. UK)
 - Search
 - Location
 - Discover
3. Make a selection and press **SELECT** to confirm.

The Podcast list menu is provided by the Podcast Portal and is therefore only accessible when Supersound 901 is connected to the Internet. Station lists and submenus may change from time to time.



- "Country" changes depending on your current location (e.g. UK). It shows local stations of your current location.
- "Search" enables you to enter all or part of station name to find a station.
- "Location" enables you to choose from the radio stations provided by any country which you choose from a list.
- "Discover" enables your radio to list the stations that have recently joined the Internet radio network.

Storing Preset Stations

Your radio can store up to 20 of your favorite Internet Radio stations. This will enable you to access your favorite stations quickly and easily.

4. While playing your favorite station, press & hold **PRESET** until display shows "Save to Preset".
5. Press  /  to select the position. Press **SELECT** and display will show "Preset stored".
6. Preset number "P #" (# = 1-20) will show on the display.

Recalling a Preset Station

3. Press **PRESET** – select station by pressing  /  / and press **SELECT** to confirm.
4. The display will show "Not set/Preset empty" if the preset position is not allocated.

Spotify Connect Mode

Your radio has Spotify Connect built in.

Press **MODE** button repeatedly to select Spotify mode.

Use your phone, tablet or computer as a remote control for Spotify.

Go to spotify.com/connect to learn how.

The Spotify software is subject to third party licenses found here:

www.spotify.com/connect/third-party-licenses

Other Streaming Services



The market provides a diverse array of streaming services. To utilize them with your Supersound 901, simply connect your device - be it a smartphone, tablet, or computer - to the Supersound 901 via Bluetooth. Then, designate the Supersound 901 as your preferred output device.

Bluetooth Mode

Pair the unit with a Bluetooth device to listen to music:

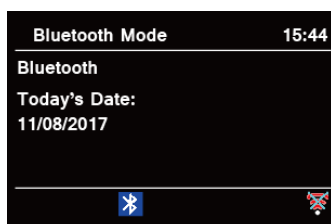
1. Press the **MODE** button repeatedly to select Bluetooth mode.



2. The display will flash in  repeatedly.
3. Activate Bluetooth on your smart device.
4. Select "Pinell Supersound 901".
5. The  icon will remain steadily on the display when connection is successful.

 **Note:** the unit will automatically switch to standby mode after 15 minutes if the source device is disconnected, switched off or the volume is too close to mute.

Audio In (RCA) Mode

Audio In allows for quick and easy connection to an MP3 player or other external audio sources.

1. Before connecting to the mains socket, use an appropriate audio cable (not supplied) to connect to your external audio device through the **Audio In** sockets at the rear of unit.
2. Connect power adapter to mains socket, press **STANDBY** button to switch unit on.
3. Press **MODE** button repeatedly to select RCA In mode.



4. In RCA in mode, you may operate your audio device directly for playback features.
5. To gain optimal volume levels, adjusting the output volume level on the audio device as well is recommended.





 **Note:** the unit will automatically switch to standby mode after 15 minutes if the source device is disconnected, switched off or the volume is too close to mute.

CD Player

Improper operation can lead to damage! Do not insert recording media other than standard CD format (e.g. mini-discs) into the CD player. These may not play correctly and be ejected. Insert only one CD at a time into the CD player.

Insert a CD (print side up) until it retracts inward. The CD player automatically loads the CD and starts playback. The display will show "Loading". Playback will start automatically once the table of contents has been read. The display shows "No Disc" when the unit is in CD mode and no CD is inserted.

The display shows the following information in CD mode: CD mode, Time and date, Elapsed playback time in minutes and seconds, Title number, Playback status (Play / Pause)

- To pause / resume CD playback, press the  button.
- To move to the next track, press the  button once.
- Press & hold the  button for fast forward through a track.
- To go to the previous track, press & hold the  button.
- To stop CD playback, press .

Adjust the CD playback (via Remote Control)

You can select different playback sequences for playing tracks using the remote control:



REP / SHUF button

REP - Repeat

- Press 1x - repeat title
- Press 2x - repeat CD

SHUF (Shuffle) - Random sequence

Music Player Mode

You can play audio from a removable drive (USB stick or USB hard disk) connected to the rear USB port on your Supersound 901.

Press **MODE** button repeatedly to select Music Player mode.

Menu options:

- USB playback
- My playlist
- Repeat play: Off/On
- Shuffle play: Off/On
- Clear My Playlist

OCTIV App

The free OKTIV app allows you to control the essential functions of your Supersound 901.

Download OKTIV from the Apple Store or Google Play Store.



Note: The smartphone and the Supersound 901 must be on the same Wi-Fi network.

General Operation

Setting Sleep (via Remote Control)

This feature enables your radio to switch to standby mode by itself after a set sleep time.

1. Press **SLEEP** button and then immediately press **◀◀** / **▶▶** to select a sleep time out of 15/30/45/60 minutes.

The sleep time options: Sleep OFF/15/30/45/60 Minutes

2. To turn the sleep function off while the sleep timer is still counting down, select "Sleep", press **◀◀** / **▶▶** to select "Sleep OFF".

Setting Alarm

Your radio includes dual alarms. Set Alarm, making sure set time at first.

1. Press **MENU** button - **Main menu - Alarms**, and then press **SELECT** to confirm.
2. Press **◀◀** / **▶▶** to select "Alarm 1" or "Alarm 2", and then press **SELECT** to confirm.
3. Press **◀◀** / **▶▶** to select options, and then press **SELECT** to confirm the setting.

Enable	Alarm active day: Off, Daily, Once, Weekends or Weekdays
Time	Alarm time: 00:00 (manually set up the time)
Mode	Alarm mode: Buzzer, Internet radio, DAB, FM or CD (If the wake-up mode is DAB and the DAB+ signal strength is low, the buzzer alarm will be triggered.)
Preset	Last listened / Saved preset station (not available for Buzzer mode).
Volume	Alarm volume
Save	Save the alarm

4. When the display shows "Alarm Saved", the alarm setting is successful. **1** or **2** will show on the display.
5. **To temporarily switch off alarm**, press **SNOOZE** button repeatedly to set snooze time for 5, 10, 15 or 30 minutes in turn. The unit will go to standby and snooze time will show on the display.
6. **To turn off alarm**, press the **ALARM** button 1 or 2 when the alarm sounds.
7. **To cancel Alarm**, refer to steps 1-3 to enable alarm "Off". **1** or **2** will disappear from display

Setting Equaliser

This feature enables you to choose a sound equalization profile. Each of the equalization setting will change the tone of the sound from your radio when selected.

1. Press **MENU** button - **System settings** - **Equaliser**, and then press **SELECT** to confirm.
2. Press **◀◀** / **▶▶** - select profile - press **SELECT**.

Equalization profile options: Normal/Flat/Jazz/Rock/Movie/Classic/Pop/News/My EQ.

3. To set up My EQ, select “My EQ profile setup”, and then press **SELECT** to confirm. Press **◀◀** / **▶▶** and select “Bass” or “Treble”, and then press **SELECT** to confirm. Press **◀◀** / **▶▶** to change the value of Bass or Treble, and then press **SELECT** to confirm. Or select “Loudness” and then press **SELECT** to set “On” or “Off”. Press **BACK** button, display will show “Save changes”. Press **◀◀** / **▶▶** and to select “YES” and press **SELECT** to save changes.

Operation via remote control:

1. Press **EQ** repeatedly until the desired option appears:
Normal/Flat/Jazz/Rock/Movie/Classic/Pop/News/My EQ EQ

Network Setup

Users encountering networking issue may find these options useful for diagnosing and fixing network problems.

1. Press **MENU** button - **System settings** - **Network**, press **SELECT** to confirm.
2. Press **◀◀** / **▶▶** to select your preferred network setting option:

Network wizard	Scan for available networks
PBC Wlan setup	Set up a WPS encrypted network (only support the router uses WPS 2.0)
View settings	View network settings such as MAC address, Wlan region, IP address etc.
Manual settings	Set wireless connection
NetRemote PIN setup	Set a PIN code for setup connection between your radio and smartphone via OCTIV app. The default PIN code is 1234
Network profile	List of registered networks
Clear network settings	Select “YES” or “NO”
Keep network connected	Keep network connected in DAB, FM, Audio (RCA), Bluetooth and standby modes

3. Press **SELECT** to confirm your setting.

Setting Time/Date

1. Press **MENU** button - **System settings** - **Time/Date**, press **SELECT** to confirm.
2. Press **◀◀** / **▶▶** to select options, and then press **SELECT** to confirm the setting.

Set Time/Date	Manually set-up both Time and Date
Auto update	"Update from DAB", "Update from FM", "Update from Network" or "No update"
Set format	12 or 24 hour format
Set timezone	Select time zone (Only available when auto update from Network)
Daylight savings	Daylight saving setting: "ON" or "OFF" (Only available when auto update from Network)
Standby Clock	Select "Analog" or "Digital"

3. Press **SELECT** to confirm your setting.

Setting Language

This feature enables you to change menu language.

1. Press **MENU** button - **System settings** - **Language**, press **SELECT** to confirm.
2. Press **◀◀** / **▶▶** to select your language, and then press **SELECT** to confirm.

Factory Reset

Doing a factory reset clears all user defined setting, replacing them with the original default values, so time/date, DAB station list and preset stations are all lost.

1. Press **MENU** button - **System settings** - **Factory Reset**, press **SELECT** to confirm.
2. Press **◀◀** / **▶▶** to select "YES", and then press **SELECT** to confirm.

Software Update – Over the network

From time to time, your radio may make software upgrades available with bug fixes and/or additional features.

If your radio detects that newer software is available, it will ask if you want to go ahead with an update. If you agree, the new software is then downloaded and installed.

After a software upgrade, all user settings are maintained.

C A U T I O N

Before starting a software upgrade, ensure that your radio is plugged into a stable mains power connection. Remove power during a software update may permanently damage the unit.

1. Press **MENU** button - **System settings** - **Software update**, press **SELECT** to confirm.
2. Press **◀** / **▶** to select “Auto-check setting”, press **SELECT** and your radio will check periodically for new version software.
3. Press **◀** / **▶** to select “Check now”, press **SELECT** and your radio will check for new version software and automatically upgrade the detected new version software.

Setup Wizard

When this unit is started for the first time, it runs through a setup wizard to configure settings for date/time and network. Once this has finished, the system is ready to use in most modes.

Redo setup wizard will not erase user settings such as searched stations and presets.

1. Press **MENU** button - **System settings** - **Setup wizard**, press **SELECT** to confirm.
2. Press **◀** / **▶** to select “YES”, and then press **SELECT** to confirm. Please refer to page 8 for more information.

Viewing System Info

This information may be requested when dealing with technical support issues.

1. Press **MENU** button - **System settings** - **Info**, press **SELECT** to confirm.
2. Press **◀** / **▶** to view “SW version”, “Spotify version”, “Radio ID” and “Friendly Name”.

Setting Backlight

This radio display has a backlight with adjustable brightness level.

1. Press **MENU** button - **System settings - Backlight**, press **SELECT** to confirm.
2. Press **◀◀** / **▶▶** to select "Power-on mode" or "Standby Mode", then press **SELECT** to confirm.
3. Press **◀◀** / **▶▶** to select backlight level, and then press **SELECT** to confirm the setting.

Timeout	<ul style="list-style-type: none">• On - During operation, brightness always remains as set in "Power-on Level"• After 10 / 20 / 30 / 45 / 60 / 90 / 120 / 180 seconds, brightness will be set according to "Dim Level"
On Level	<ul style="list-style-type: none">• High• Medium• Low
Dim Level	<ul style="list-style-type: none">• Medium• Low• Very Low• Off

Troubleshooting

If a problem occurs, it may be due to something very minor. The following table contains various tips.

Problem	Solution
No Power.	<ul style="list-style-type: none">● Ensure the mains cable is properly connected or battery power is not used up.● Make sure that the unit is turned on.
The unit does not respond when pressing any buttons.	<ul style="list-style-type: none">● The unit may freeze up during use. Switch the unit off and then on again to reset it.
Cannot find my network.	<ul style="list-style-type: none">● Make sure the Wi-Fi router is plugged in and working.● Reconnect the radio to your Wi-Fi.● Check you radio is within 5m of your router.
Poor radio reception.	<ul style="list-style-type: none">● Make sure the antenna is fully extended.● Electrical interference in your home can cause poor reception. Move the unit away from them (especially those with motors and transformers).
Desired station not found.	<ul style="list-style-type: none">● Weak signal. Search manually.
I cannot find the radio on my Bluetooth device.	<ul style="list-style-type: none">● Ensure the Bluetooth function is activated on your Bluetooth device.● Re-pair the unit with your Bluetooth device.

If any functional abnormality is encountered, unplug the unit from the mains socket and reconnect it again.

Specifications

<p><u>PLAYS</u></p> <ul style="list-style-type: none"> • DAB/DAB+ • FM (87.5-108MHz PLL) • Internet Radio: more than 60.000 stations worldwide • Podcasts • Bluetooth Streaming • Spotify Connect • Music Player (USB) • CD Player <p><u>CONNECTIVITY</u></p> <ul style="list-style-type: none"> • Headphone 3.5mm minijack • USB • Wi-Fi and Bluetooth • Optical and Coax digital input • AUDIO IN (RCA) 	<p><u>FUNCTIONS</u></p> <ul style="list-style-type: none"> • 10 preset buttons on remote control • Clock and Dual Alarm • Sleep and Snooze • Menu in 13 languages: EN, DE, DK, NL, FI, FR, IT, NO, PL, PT, ES, SE, TR • Equaliser • Backlight settings • Wireless Control App - OCTIV • SW upgrade via internet 	<p><u>SOUND</u></p> <ul style="list-style-type: none"> • Speaker: 2 x 1" tweeter • 2 x 4" broadband • 6.5" subwoofer • Output: 80 Watt RMS <p><u>DESIGN</u></p> <ul style="list-style-type: none"> • Built in Wi-Fi antenna • FM Rod Antenna (removable) • Sound-optimised fabric • 3.2" Colour TFT display • Full functional remote control (2x AAA batteries included) • AC 100-240V, 50-60Hz • Unit dimensions (mm): 850(B) x 350(T) x 155(H) • Weight (kg): 12.6
--	--	--



This symbol on the product or in the instructions means that your electrical and electronic equipment should be disposed at the end of its life separately from your household waste. For more information, please contact the local authority or your retailer where you purchased the product.



Modino AS hereby declares that this wireless device is in compliance with the following directives:
 2014/53/EU (RED)
 2011/65/EU (RoHS)

* Information in this manual is subject to change without notice.

Pinell is a label of Modino AS (www.modino.no)
 Trondheimsveien 183, 2020 Skedsmokorset, Norway (Email: Support@pinell.no)